

---

# *Lhotae*

## Owner's Manual and Service Booklet

---

Serial Number: \_\_\_\_\_

The data and statements contained within this manual may be changed without prior notice. No part of these documents may be copied or transmitted for any purpose in any manner or by any means, either electronic or mechanical, without explicit written permission from UP International.

© 1995-2016 UP International



Version 1.2  
Effective: 09/2016  
Updated: 09/2016

# Table of contents

<b>WELCOME IN OUR TEAM .....</b>	<b>5</b>
<b>SAFETY INSTRUCTIONS.....</b>	<b>6</b>
<b>CORRECT BEHAVIOUR IN RELATION TO THE ENVIRONMENT .....</b>	<b>6</b>
<b>DEVELOPMENT OF PARAGLIDERS .....</b>	<b>7</b>
<b>TECHNICAL DESCRIPTION .....</b>	<b>7</b>
<i>Purpose .....</i>	<i>8</i>
<i>LTF and EN classification.....</i>	<i>8</i>
<i>Target group and recommended flying experience.....</i>	<i>8</i>
<i>Necessary skills for normal flights.....</i>	<i>8</i>
<i>Necessary skills for dealing with disturbances.....</i>	<i>8</i>
<i>Necessary skills for dealing with rapid descent methods.....</i>	<i>8</i>
<i>Suitability for training .....</i>	<i>8</i>
<i>Recommended Takeoff weight.....</i>	<i>8</i>
<b>TECHNICAL DATA UP LHOTSE .....</b>	<b>10</b>
CONSTRUCTION.....	11
<i>Front Section Support.....</i>	<i>11</i>
CANOPY MATERIAL.....	12
LINE MATERIAL .....	12
LINE SYSTEM.....	12
RISERS.....	13
UP BACKPACK .....	15
<i>Adjustment of the back pack.....</i>	<i>15</i>
<i>Packing tips .....</i>	<i>15</i>
<b>BEFORE THE FIRST FLIGHT .....</b>	<b>16</b>
ADJUSTMENTS .....	16
<i>Position of the brakes .....</i>	<i>17</i>
<i>Speed system.....</i>	<i>18</i>
SUITABLE HARNESSSES.....	18
RESCUE SYSTEM .....	19
USE OF THE UP LHOTSE .....	19
AEROBATICS .....	19
MOTORISED PARAGLIDING.....	19
<b>FLIGHT PRACTICE AND SAFETY.....</b>	<b>19</b>
<b>FLIGHT PRACTICE .....</b>	<b>19</b>
PRE-FLIGHT CHECK.....	19

THE START PHASES.....	20
SPEED CONTROL .....	21
<i>Using the brakes.....</i>	21
<i>Using the Speed System .....</i>	21
TURNING .....	21
LANDING.....	22
WINCH TOWING .....	22
<i>Attaching the towline release system.....</i>	22
<b>FLIGHT SAFETY .....</b>	<b>23</b>
THERMALS AND TURBULENCE .....	23
GETTING DOWN FAST .....	23
<i>Steep Spiral Dive.....</i>	24
<i>B-Line Stalls .....</i>	24
<i>Big Ears.....</i>	25
<b>FLYING OUTSIDE THE NORMAL FLIGHT ENVELOPE .....</b>	<b>25</b>
BEHAVIOUR IN EXTREME SITUATIONS .....	25
COLLAPSING THE PARAGLIDER .....	26
<i>Asymmetric collapse.....</i>	26
<i>Cravatte.....</i>	26
<i>Full frontal collapse.....</i>	26
THE STALLS .....	26
<i>Deep Stall.....</i>	27
<i>Fullstall .....</i>	27
<i>Spin .....</i>	28
WINGOVERS .....	28
EMERGENCY STEERING.....	28
FURTHER REFERENCES .....	28
<i>Rain-induced deep stall.....</i>	28
<i>Adhesive logos .....</i>	29
<i>Overloading .....</i>	29
<i>Salt water.....</i>	29
<b>MAINTENANCE AND CLEANING.....</b>	<b>29</b>
TAKING CARE OF YOUR PARAGLIDER .....	29
<i>Packing the wing.....</i>	29
<i>Paraglider fabric.....</i>	31
<i>Paraglider lines.....</i>	32
<i>Storage and transport.....</i>	32
CLEANING.....	33
CHANGING FSS BATTENS .....	33
<b>CHECKS AND REPAIRS.....</b>	<b>34</b>
MAINTENANCE.....	34
<i>Airworthiness Check.....</i>	34

UP Craftsmanship.....	34
UP WARRANTY .....	34
National warranty conditions.....	35
International UP warranty .....	35
CHECKING THE UP LHOTSE .....	35
PACKING AND CHECKING OF THE RESCUE SYSTEM .....	36
SENDING THE UP GLIDER AND OTHER UP PRODUCTS .....	36
<b>DISPOSAL .....</b>	<b>36</b>
<b>UP HOMEPAGE.....</b>	<b>36</b>
<b>SOME FINAL WORDS.....</b>	<b>37</b>
<b>ATTACHMENTS .....</b>	<b>38</b>
LINE PLAN .....	38
LINE DATA .....	39
SERVICE BOOKLET .....	40
GLIDER- AND PILOT DATA.....	40
PRODUCT REGISTRATION CARD .....	45

### Important

The following symbols are used to draw attention to particular sections:



#### **WARNING!**

Failing to comply with instructions given here may lead to injury or death!



#### **BEWARE!**

Failing to comply with instructions given here may cause undue wear to, or even damage, your new wing.



#### **NOTICE**

This pictogram indicates a tip or some helpful extra knowledge.

---

## Welcome in our team

Congratulations on the purchase of your new UP Lhotse. UP International is renowned across the globe for designing and building the finest paragliders available – paragliders characterised by maximum safety, performance and quality in every aspect.

Please take a little time to complete and send the reply card found in the back of this manual. This way we can keep you informed of all new products and developments at UP, as well as any technical information about the UP Lhotse.

We would also be delighted to hear any feedback you have concerning the glider. This is only possible once we have received your product registration, either through completing and sending the attached product registration card, or by doing the same online via [www.up-paragliders.com>service>product](http://www.up-paragliders.com>service>product) registration. Your completed product registration is also needed should any warranty issues arise.

If you have any questions regarding your paraglider or auxiliary equipment please ask your local dealer or feel free to contact us here at UP directly.

Have fun with your new UP Lhotse!

**UP International Team**

## Safety instructions



Paragliding is an extremely demanding sport requiring the highest levels of attention, judgement, maturity, and self-discipline. Due to the inherent risks in flying this or any paraglider, no warranty of any kind can be made against accidents, injury, equipment failure, and/or death. This glider is not covered by product liability insurance. Do not fly it unless you are personally willing to assume all risks inherent in the sport of paragliding and all responsibility for any property damage, injury, or death, which may result from use of this paraglider.

Please read this owner's manual thoroughly before your first flight with the UP Lhotse so that you are fully acquainted with your new glider. This manual gives you information on the entire specific and general flying characteristics of the UP Lhotse, but it does not replace attending a paragliding school. It is important to note the following points:

- at the time of delivery the UP Lhotse conforms to LTF NFL II-91/09 and EN 926-2:2014 requirements (see certification information later in this manual),
- any changes being made outside the permitted range of adjustment invalidate any and all claims under the warranty,
- using this paraglider is exclusively at the risk of the user; the manufacturer or distributor assumes no responsibility for accidents occurring while using it,

- it is assumed that the pilot is in possession of the necessary qualifications and provisions of any relevant laws are observed,
- when reselling the wing please make sure you also give this manual to the new owner. The manual is an integrated part of the paraglider and is required for the wing to keep its certification.

## Correct behaviour in relation to the environment

Paragliding is a particularly nature-friendly sport. This makes it all the more important that we as paraglider pilots behave in a responsible way towards both the environment and the people sharing it with us. We encourage you to treat nature with respect, to stay on marked hiking trails when walking to takeoff or hiking out from an XC landing, to avoid unnecessary noise, to never litter and to observe all local regulations.

Please also make sure to comply with legislation regarding protected areas, privately owned property or hunting arenas – this ensures the least possible friction in relation to other users of the great outdoors, to the benefit of both yourself and the sport as a whole.

---

## Development of paragliders

Admitted; we're proud of our history. No other company in the free flying world can look back on such an expansive history as we can. The UP story started back in 1970 when Pete Brock graduated from the Art Center, a world famous school for design and engineering in Pasadena, California, and promptly created some of the most legendary race cars ever – the Daytona Coupe from General Motors was one – and then went on to become fascinated by the emerging sport of hang gliding – at that time probably the maddest pastime of them all. After founding Ultralite Products he introduces his first wing, the Dragonfly, and soon the new company becomes known under the UP acronym...

Pete Brock's spirit survives to this day in everything we do at UP International – we still have our very own way of seeing things and designing things. This entails building paragliders that are not only as safe as they come, they must also meet the very high standards we set ourselves. Among these is the continued use of the most advanced technology available both in the designing and manufacturing process, but also the feel, the handling and the performance of the finished product. All this because we're addicted to building wings that will fascinate you. A good paraglider is comprised of a number of interacting factors of which looks, feel, handling and performance are but a few. Only when all these come together in the final product can we claim to have built a wing that is homogeneous and pleasurable to fly; and only then we're happy, and ready to introduce our new UP baby to the free flying world.

Our gliders are developed using state-of-the-art CAD software. Our programs allow us to do the initial flight testing in a virtual environment where we can simulate a great many things before even assembling the first prototypes.

Once we're happy with the new prototype's behaviour in the virtual environment, the program generates the templates after which the glider is sewn. When a new prototype arrives from our proto-building experts everyone at UP is excited about the prospects of trying it out in real life. The practical tests may show that further modifications are needed – these may be carried out on the existing wing, or a new prototype is built with the mods already incorporated. In exceptional cases this may continue through several prototypes, for only when we're 100% satisfied do we submit our new wing to homologation testing with the testing houses. We owe it to our customers, and to our own history, to be particular about which products earn the UP badge.

## Technical description

The UP Lhotse was built to fulfil the expectations to a modern, safe and fast Intermediate wing. The launching is excellent and the performance figures impressive.

As with all UP products, the materials used have been carefully chosen for their outstanding quality and strength to guarantee a long and trouble-free service life.

Further construction details, including line lengths, are included in the certification specification sheets, which form part of this manual. Any technical changes will appear in the appendix.

## Purpose

According to LTF 91/09 the Lhotse is an air sport vehicle (class paraglider) with an empty weight of less than 120 kg.

## LTF and EN classification

The UP Lhotse is certified to the following classification: LTF09/EN B for all sizes.

## Target group and recommended flying experience

Thermal and XC pilots flying regularly and possessing advanced flying skills. We believe that a minimum of 20-30 hours of airtime/year is a sensible limit to set.

## Necessary skills for normal flights

Due to the somewhat shorter brake line travel (compared to EN A wings)\*, the reduced roll dampening and the dynamic handling, the flying and handling behaviour of paragliders in this class requires advanced, precise skills along with the ability to fly instinctively and intuitively.

## Necessary skills for dealing with disturbances

The glider behaviour in connection with disturbances requires somewhat higher skills than what is the case on LTF/EN A wings. The pilot must possess a certain amount of automated reactions and be able to react quickly to incidents. We recommend making sure that you have the skills to sense disturbances before

they happen, and to deal with them correctly once they do. Of particular importance here are adequate skills for dealing with asymmetrical or frontal collapses. Should you not feel fully up to the task we recommend visiting a SIV clinic with your new wing.

## Necessary skills for dealing with rapid descent methods

The behaviour during manoeuvres like spiral dives or b-line stalls in this class can be demanding. The pilot should possess adequate skills for the safe execution of these rapid descent manoeuvres. In case of insufficient skills or experience in this department we strongly recommend partaking in an SIV clinic with the new wing.

## Suitability for training

Although a very simple and forgiving wing for its class we do **NOT** consider the UP Lhotse suited for initial training.

## Recommended Takeoff weight

The UP Lhotse is manufactured in three sizes. Each size is optimised for the middle of the weight range, but can be flown anywhere within the weight range. In order to help you find the ideal size for your weight we have compiled the following practical tips:

If your total takeoff weight is within the middle 1/3 of a size's weight range then this is the size for you. In this range you will have the ideal compromise between dynamic handling and docile behaviour. We recommend this wing loading



---

especially for pilots mainly flying in flatland regions.

Pilots finding themselves in the middle, between two sizes need to approach the process somewhat differently. Experienced pilots will generally know how they prefer to fly, i.e. if they like to be heavy on their wing or rather would have a little buffer upwards, and will choose their size accordingly.

Pilots with less experience are likely to prefer the somewhat damped reactions obtained from flying at lower wing loadings – this speaks for choosing the larger of the relevant sizes.

And finally, pilots preferring more dynamic rides will want to load their wings up well, and will be choosing a smaller size.

## Technical Data UP Lhotse

Size	S	M	L
Surface area flat [m <sup>2</sup> ]	22,8	24,8	26,9
Surface area projected [m <sup>2</sup> ]	19,2	21	22,7
Flat span [m]	11,5	12,0	12,5
Projected span [m]	8,9	9,3	9,7
Flat aspect ratio	5,7	5,7	5,7
Projected aspect ratio	4,1	4,1	4,1
Number of Chambers	49	49	49
Total line length incl. Brake [m]	253	265	275
Total # of lines incl.Brake	138	140	141
Glider weight [kg]	3,0	3,3	3,6
Takeoff weight [kg]	60-90	75-100	85-120
Accelerator travel [cm]	14,5	14,5	16,5
Number of risers (split A-risers)	3+1	3+1	3+1
Trimmer	no	no	no
LTF/EN Category	B	B	B
Description	Intermediate		

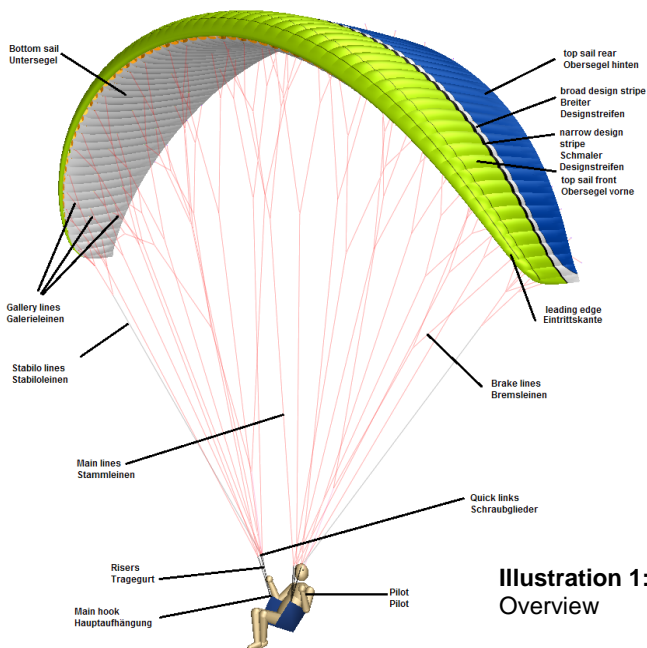
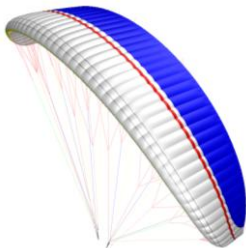

**Illustration 1:**  
Overview

## Construction

The UP Lhotse is the true all-rounder, a cross-country wing for almost everyone including W&F enthusiasts. The handling is optimised for maximum performance in lift, and for transmitting information about the air to the pilot. It is thus a more communicative wing than, say, the new UP Makalu 4 – think of it as the ideal mix between a Makalu 4 and a Summit XC3. This makes it a great tool to learn and progress on, for pilots wishing a more relaxed flying experience than the Summit XC3 will offer, or for those eager to some day fly high-performance wings.

As with all UP wings, the new UP Lhotse is designed to perform. Here at UP we think of our new baby as the perfect mile-muncher, going through XC kilometers like Smarties and being very relaxed about it all the way. The way it flies is reminiscent of the UP Summit XC3, just easier, so the novice XC pilot may clock up those important hours and km safe in the knowledge that the wing will be looking after them.

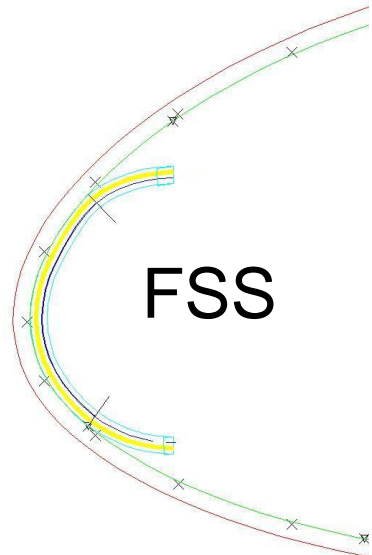

**Illustration 2:** CAD-drawing UP Lhotse

The UP Lhotse uses a similar New Generation Aerofoil to the one used on the Summit XC3 and the Trango XC3, but optimised for this category of wing. This

means a moderate shark-nose shape, perfect for biting through turbulence and staying open when the going gets rough. Just like its performance siblings it converts bumps to altitude well, meaning it will help the budding XC pilot get the most out of every outing both in terms of flying pleasure and experience accrual.

## Front Section Support



**Illustration 3:** FSS

UP was first with the Aerofoil Stabilising System, an idea that has since been widely accepted in the industry. The Lhotse uses a modified version of the same, and we have chosen to call this the FSS. Instead of Mylar® the FSS comprises a Nylon® batten that defines the leading edge

curvature and helps keeping the cell opening open at all times. This Nylon® batten is unsusceptible to bending damage and has no ageing properties – it will normally outlast the rest of the canopy by a good margin. This means that the UP Lhotse will retain its perfect launching characteristics all through its service life. In the unlikely event that a batten should break it can be replaced in a few easy steps – please refer to the chapter “Replacing FSS battens” for guidelines.

## Canopy material

The UP Lhotse is sewn from polyamide cloth, which is particularly stretch-resistant and durable, and is specially treated for maximum UV-resistance.

At UP we are always testing new materials to see if our wings can benefit from new developments in the textile industry. After comprehensive tests we have settled on the following Porcher Marine/Dominico Textile material mix for the Lhotse

Top surface front	Porcher Skytex 32 Universal, 32 g/m2
Top surface thin stripe	Porcher Skytex 38 Universal, 38 g/m2
Top surface broad stripe	Porcher Skytex 27 Classic, 27 g/m2
Top surface rear	Porcher Skytex 27 Classic, 27 g/m2
Bottom	Porcher Skytex 27 Classic, 27 g/m2
Cell walls	Porcher Skytex 27 Hard, 27 g/m2

This mix comprises the best compromise between weight/bulk and longevity.

## Line material

The lines used on the UP Lhotse are all sheeted and unsheeted Dyneema®- and Aramid lines made by Edelrid, Liros and Cousin in different diameters

A new manufacturing process in which the lines are pre-stretched makes these lines particularly stretch-resistant, and they have little or no tendency to shrink. Their

break-load is noticeably higher than that of comparable Aramide lines, and unlike Aramide lines they are completely unsusceptible to bending-cycle damage.

## Line system

The entire line system is formed from individual lines, which are sewn and looped at both ends. The single line levels are connected over a special hoop technology (the "handshake" loop) to prevent a weakening of the core and a loss of strength. The lines and stitching are subject to rigorous production controls, to ensure high and consistent manufacturing quality.

The lines of each wing section consist of four groups and the brake lines:

- A-Level: AI-All
- Split A-Level : AIII
- B-Level: BI-BIII,STI
- Split C-Level: CIII
- C-Level: CI,II
- Brake lines : BRKI

The brake lines are collected at one main control line per side. This control line runs through a pulley attached to the C-Riser and is marked with a black dot at the point where it should be tied to the brake handle swivel. The brake is pre-set so that the glider is at 0 degree brake when the toggle is free. Please don't change the main brake lines without checking the new length carefully at a suitable training hill before flying!

The line bundles (AI,II and AIII, B and C) are colour coded for easy identification and handling. All main lines of each level are looped together and attached to delta quick links,

---

which are connected to the risers. The quick links have special line collectors to prevent lines slipping.

## Risers

The split A risers and B risers are colour marked to improve ground handling and B-lining/Big Ears.

A Risers: Red

A3 Risers (for Big Ears): Green

B Risers: Blue

C Risers: Black/no marking

In order to accommodate different pilot sizes the Lhotse risers are length-adapted to the canopy size S and M have shorter risers than L. This little detail improves the ergonomics of the wing and makes all the different manoeuvres (b-line stalls, BigEars) more accessible to every size of pilots, from the smallest to the tallest.

The speed system is optimised along the same lines.

We use a very similar riser design for our competition wings. They allow for very high top speeds with low sink values and give impressive stability at high speeds.

Once activated the speed system pulls simultaneously on the A's and B's. This maintains the angle of incidence around the leading edge and causes only minimal influence to the collapse resistance properties of the wing.

Top speed is reached when the top pulley touches the bottom pulley of the speed system, down near the karabiner.

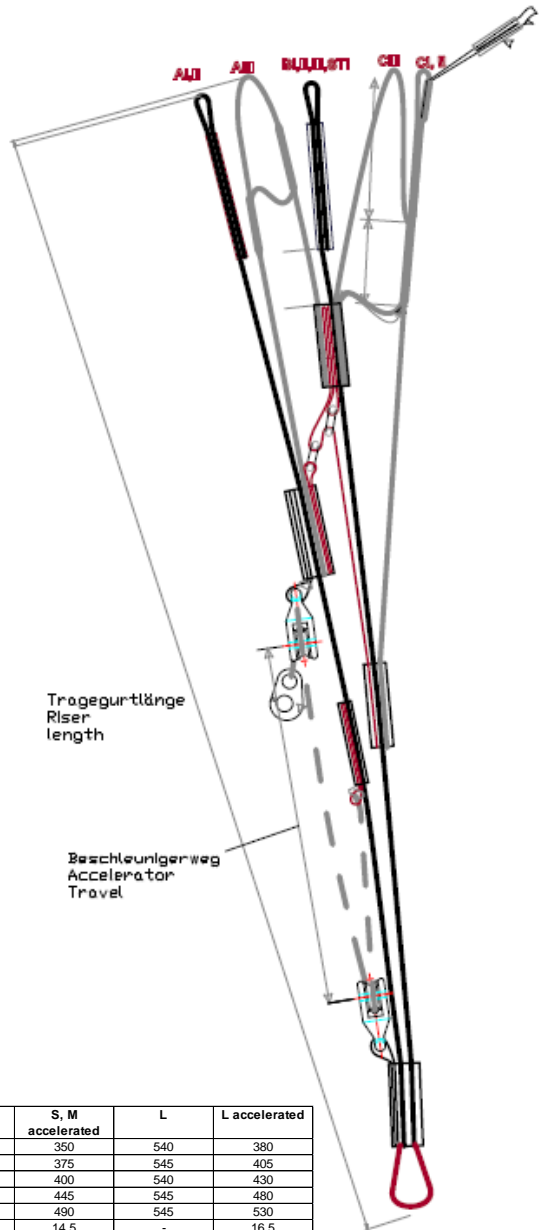

Riser length [mm]	S, M	S, M accelerated	L	L accelerated
A I, II	500	350	540	380
A III	505	375	545	405
B I, II, III, ST I	500	400	540	430
C III	505	445	545	480
C I, II	505	490	545	530
Accelerator travel (pulley on pulley)	-	14,5	-	16,5

**Illustration 4:** UP Lhotse riser

## UP Backpack

The UP Lhotse is delivered with a special paraglider backpack, which fulfils the demands of very high luggage volume and ergonomically optimised comfort.

We have built in an anatomical carrying system that allows an optimised load distribution for maximum comfort. The S-shaped shoulder straps allow full adjustment and the detachable chest strap prevents the shoulder straps from slipping off the shoulders.

The load control straps attached to the shoulder straps can be set either loose, to aid ventilation, or tight, for extra stability. They should rise from your collarbone at about a 45° angle.

A hip belt is also incorporated to assist overall comfort. If the hip belt is tightened then the shoulder straps can be released slightly to transfer the load away from the shoulders. The hip belt is fitted with stabilisation straps, which can be tightened to help stability, or loosened for extra freedom of movement. The hip belt is removable for when packing size is critical, or the pack is being transported by

air. It is important, especially when there is a long trek involved, that the backpack is adjusted for maximum comfort. The following advice should be considered when packing.

### Adjustment of the back pack

When fully loaded, all compression straps should be tightened to secure the load in the pack. All carrying straps should be set fully loose and the pack then put on your back. The hip belt should be fastened and tightened to rest approximately in the middle of the hip. Any slack should be taken out of the shoulder straps, and the chest strap should be done up. The load control straps at the shoulders and hips can now be tightened to achieve the desired stability.

### Packing tips

Packing the UP paraglider rucksack correctly will make it a pleasure to carry. A couple of easy tips can help you get it right. Failing to follow these tips will adversely affect your carrying comfort.

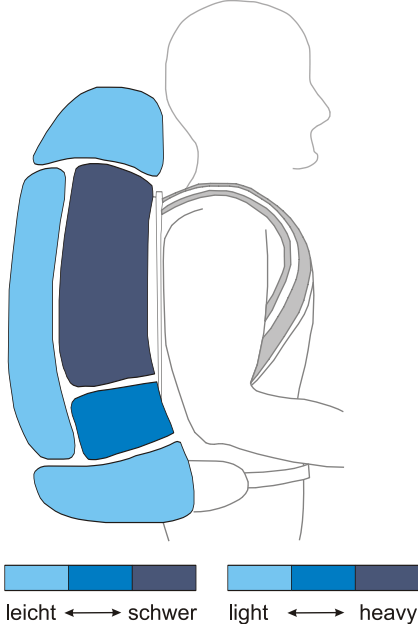

**Illustration 5:** UP back pack (Standard version)

The centre of gravity of the load should be as close to the vertical centre axis of the carrier, while also being situated as high on the back as possible. This allows for a vertical posture and minimises the leverage of the load against the natural posture of the carrier. It also helps by reducing the oscillations of the load while walking.

The drawing shows the ideal load distribution in the UP rucksack. Loaded like this the carrying comfort will be optimal. Start by placing the heaviest items close to the shoulder blades, with lighter items over and under this region. The lightest items should be placed the furthest from your back.

Do not fasten any objects to the exterior of the rucksack, as these are unprotected against theft and can also get caught on protruding points when entering or exiting lifts, cars or buses.



**Illustration 6:** Ideal load distribution in the UP rucksack

## Before the first flight

The UP Lhotse is delivered with a rucksack, compression bag and -strap, repair materials and this manual. The manual may also be downloaded from the UP website. Every Lhotse delivered has been minutely checked at the factory, and corresponds exactly to the wing certified by the DHV.



**ATTENTION!** The Lhotse must be test-inflated on flat ground, and the first flight must be carried out by a professional, before the wing is delivered to its new owner.

## Adjustments

The UP Lhotse has undergone an extensive development program and series of flight tests to ensure that the production model exhibits the optimum characteristics with regard to safety, handling and flight performance.

As with all products from UP International, the UP Lhotse is manufactured to the highest quality and precision. The line lengths of each glider are individually checked and recorded before dispatch.

Under no circumstances should the lengths of the lines or risers of the UP Lhotse be altered in any way.



**WARNING!** Any change to the configuration of the wing will invalidate certification!

The only change allowed is to the length of the lower brake line. This should only be done by an experienced person.



## Position of the brakes

The UP Lhotse is delivered from the factory with what we feel is the best brake position for most pilots. But tall or short pilots, or those with a harness with non-standard attachment points might consider it necessary to change the position of the brake handles.

If the brakes are to be shortened, it is extremely important to avoid the adjustment affecting the glider's trim speed. There must always be some slack in the brakes when they are fully released. This can be checked with the glider inflated above the pilot's head. There should be a noticeable bow in the brake lines, and the brakes should be having no effect on the shape of the trailing edge.

If the brake lines are to be lengthened, it is important to ensure that the pilot can still stall the canopy (i.e. during extreme manoeuvres or landing) without the need to take wraps.

If you do feel the need to change the brake line lengths, do so a little (3-4 cm) at a time, and preferably whilst at an easy training slope. Check especially that both lines are the same length, as any asymmetry will lead to tiring and possible dangerous flying characteristics.

If you have any questions or concerns with reference to the brake line lengths then seek advice from either your UP dealer or directly from UP International.



**BEWARE!** Loose or incorrect brake knots can cause serious accidents through loss of the steering of the glider!

## Speed system

It is important that the speed system is connected correctly, and the length checked, to ensure smooth operation in flight.

The link between the foot stirrup and the risers consists of two cords and two brummel hooks. The speed stirrup itself is composed of a foot bar and webbing with loops sewn on either end to attach the cords. These cords should be run up through the eyelets and pulleys on the harness to connect with the pulley system on the front of the risers (see illustration).

This illustration refers to the UP harness, but many harnesses are similar. If in any doubt, please ask the harness dealer/manufacturer.

The length of the cords should be set so that, at full leg extension, the pulleys on the risers are just touching each other. Any shorter and the stirrup will be difficult to reach; longer and the top of the speed

range will be unavailable.

During take off it is advisable to fix the accelerator stirrup underneath the harness to avoid any danger of tripping over it.

## Suitable harnesses

The Lhotse can be flown with any harness with the main suspension point at around chest height. The lower the suspension points the more the harness will respond to weight shift.

The recommended distance between the karabiners depends on the pilot weight:

<50kg: 38cm

50-80kg: 42cm

>80kg: 46cm

The harness design should also guarantee that it is possible to accelerate the UP Lhotse up to the

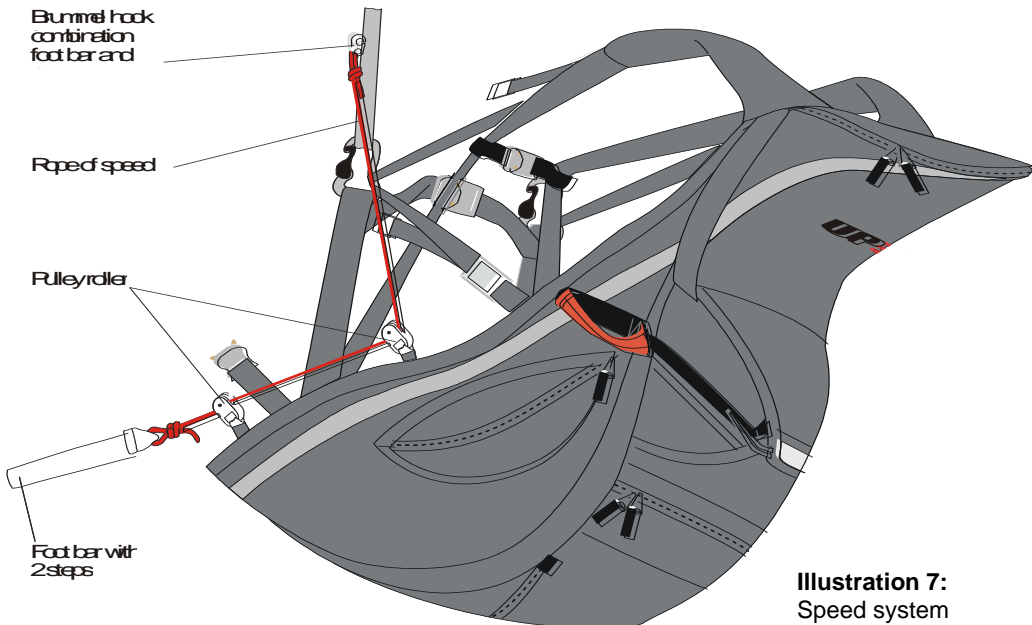

**Illustration 7:**  
Speed system

maximum speed.

Please note that different harnesses can cause very different wing characteristics in extreme situations (like increased risk of twists with cocoon harnesses).

Note that the height of the hang point also affects the brake line length. If you have a question about your UP harness, contact your dealer or UP International.

## Rescue system

It is strongly recommended that you have a rescue system (reserve parachute) fitted at all times. In some countries it is mandatory, so check if you plan to travel. Make sure that the reserve system you have is the correct size, and that you are fully conversant with its use.

For fitting the reserve system, follow the instructions of the harness manufacturer.

## Use of the UP Lhotse

The UP Lhotse has been developed and tested solely for foot launched and winch launched paragliding flights. It is not allowed and potentially dangerous to use the glider for any other purpose.

## Aerobatics

The UP Lhotse has not been developed, constructed and/or tested for aerobatics use.



**WARNING!** The glider has not been certified for aerobatics. Performing aerobatics with the UP Lhotse or any other paraglider can be very dangerous. Doing aerobatics can induce flying configurations well beyond the tested flight envelope, and can lead to total loss of

control. Aerobatics can also overload your glider and break it in flight.

## Motorised Paragliding

The UP Lhotse has not been tested for use with any kind of engine.

If you wish to fly your UP Lhotse with a motor please get in touch with the manufacturer of the engine unit, with UP International GmbH and with the governing body for ultra light flying in your area, to check on certification of this configuration.

## Flight practice and safety

Both of the following chapters (Flight practise and Flight safety) describe fundamental aspects of flying paragliders. In no way do they substitute proper training, nor should any of the content therein be unknown to any pilot who has chosen to fly a performance paraglider like the UP Lhotse.

## Flight practice

### Pre-flight check

Make sure whenever you get your UP Lhotse back from somebody else to check the glider very carefully if you are not the only pilot flying it. Ask if there was anything that could have damaged any part of the glider, if the pilot has found any part that needs to be replaced or if they noticed any strange flight behaviour. Make sure

you do the same when you lend your glider to somebody else.



A thorough pre-flight inspection should be performed prior to each flight. A careful pre-flight check is a must for any and all airplanes – also the UP Lhotse. Please apply the same care and attention before EVERY flight!

Before every launch you should carry out the standard 5-point checking procedure. It is a good idea to do the checks following the same sequence every time to minimize the risk of omitting something.

1. Unpack and arrange your glider in a semi-circular manner. This shape ensures that the centre cells inflate before the tips. When unfolding your glider, observe the wind direction and arrange your glider so that it is pointed directly into the wind.
2. The lines must be arranged so that there are no tangles and the A-lines are uppermost. Once the lines are free and untangled, check to make sure that they all go directly from the riser to the glider without going over the top of the wing. Launching with a line over the wing is extremely dangerous! It is also important that the brake lines are free and not tangled.
3. Next check that you have put the harness on correctly, and ensure that both leg straps and the chest strap are closed and adjusted. Also check the rescue system pins and deployment handle.
4. Right before the launch you should check the air space (also behind you).
5. Once again check the wind direction before take-off.

## The start phases

The take-off characteristics of the UP Lhotse are extremely straightforward. Only a gentle forward pressure on the A risers is necessary and the glider will inflate evenly and climb above your head. The glider has no tendency to hang back behind you or to overshoot over your head.

With the A risers and the brakes in your hands, have another look at your unfolded glider. By stronger wind the start can be facilitated if the UP Lhotse is inflated solely with both the internal A-risers (front A-riser). Make sure that you are centrally positioned in the middle of the wing, and that the wing is facing into wind. The middle of the canopy is marked by the UP logo at the leading edge.

Inflate the glider with a steady run and remember to position your arms so that they are a continuation of the A risers. As the glider comes above your head, you should glance up to see that the entire canopy is inflated and flying. The UP Lhotse has a low surge tendency, so there is usually no necessity to brake to stop the glider from over-flying you.

Directional control should only be attempted when the glider is above your head. Excessive braking will cause the wing to drop back.

Only after checking that the wing is properly inflated do you apply slight brake pressure and accelerate rapidly down the hill. After a few steps you will reach flying speed and become airborne.



**NOTE:** The decision to actually take off or not is only really taken towards

the end of the control phase. The pilot accelerates the start run and is airborne. Depending on the inclination of the launch paddock it may make sense to brake a bit in this phase. Once airborne and at a safe altitude the pilot slips into the seated position in the harness – **WITHOUT RELEASING THE BRAKE HANDLES**. If this is not possible then the pilot may hold both handles in one hand whilst assisting the seating with the other.

## Speed control

### Using the brakes

The UP Lhotse has a wide useable speed range, coupled with excellent stability at all speeds. The speed can be set with the brakes to optimise performance in any situation.

Maximum glide speed is achieved with the brakes released completely, whereas minimum sink speed is with approximately 10-15 cm of brake applied. Further braking will not improve the sink rate, but the brake pressure increases noticeably as the glider reaches minimum speed.



**BEWARE!** Flying close to the stall point is very dangerous and should be avoided. At speeds below minimum sink the danger of entering an unintentional stall or spin is increased dramatically.

### Using the Speed System

The UP Lhotse is equipped with a very efficient speed system, working over a foot stirrup as usual. By engaging the speed system the true air speed may be increased by around 11 to 13 km/h. Being familiar with the use of the speed system is an important skill to have in paragliding.

The speed system should be used when you are flying through sinking air, when trying to achieve best glide in a headwind, or trying to cover the ground as quickly as possible. But it is important to remember that the glider will be more susceptible to collapses at high speeds, so the speed system should not be used in extreme turbulence. If a collapse occurs with the speed system applied then it should be released immediately. Some warning of an imminent collapse is afforded by the tension felt in the speed system; should the tension suddenly reduce then the stirrup should be released and the glider returned to normal trim speed.



**BEWARE!** All extreme flight situations, such as collapses, happen more dramatically at increased speed. Therefore the speed system should not be operated near the ground or in noticeable turbulence.

## Turning

The UP Lhotse has been developed to meet the demands of intermediate pilots. The brakes have been designed so that the first 15 to 20 cm of travel will cause a soft and direct turning, whereas larger movements will give the glider an agile and nimble feel.

Brake input and amount of weight shift induced will define the radius and bank angle on the UP Lhotse, and will allow it to be controlled with ease. Using weight shift in combination with brake input will result in flat turns with minimum height loss and is in fact always the most efficient control method. The radius of the turn is then

controlled with the brake line whereas the bank is controlled through weight shift.

If needed the UP Lhotse will turn very tight. To do this, apply some brake input on both sides, then release the outside brake whilst applying further brake on the inside – this will reduce turning radius to a minimum.

When brake input is increased beyond approximately 50% on one side, the UP Lhotse begins a fast and steep turn, which can be made into a steep spiral (refer to chapter heading "steep spiral").

## Landing

The UP Lhotse is easy to land. While pointing into the wind, the pilot should fly the wing fast until approximately one meter above the ground, and then apply both brakes completely. When landing in stronger wind, less brake is required. Landing from steep turns should be avoided due to the risk of an uncontrolled pendulum reaction.

## Winch towing

The UP Lhotse tows easily. There are no special techniques that need to be employed, but consideration should be given to the following points:

- Especially when you are towing at an unknown field, make sure that you are fully aware of any local conditions and peculiarities. Ask the local pilots if you are at all unsure.
- During the launch, ensure that the glider is completely inflated and over your head before giving the 'start towing' signal. If the glider is not central over your head do not continue with the tow. Any corrections attempted through the brakes during this critical phase may result in the

canopy deflating again, or in the tow progressing with a non-flying wing; if tow tension is applied when the glider is not correctly positioned then a 'lock out' or a stall could occur.

- Try to avoid large brake inputs until you are reasonably high. Emphasize weight shift if course correction is necessary close to the ground.
- Do not try to climb steeply during the first part of the tow. Good airspeed is essential.
- Do not use a towline tension greater than 90 daN at any time during the tow.
- All persons involved with the towing operation should be suitably qualified and experienced. All equipment used should, where necessary, be certified, and a tow permit should be valid for the field being used.

## Attaching the towline release system

The optimal attachment point for the towing line release is always in the system's centre of gravity. On a paraglider that means the connection point between the risers and the harness, preferably right onto the lower end of the risers. UP International has developed special tow-release connectors for the UP Lhotse to ensure the optimal connection between the pilot and the towing line. For safety reasons we suggest that you always use these connectors when towing the UPLhotse.

When using towing line release systems incorporating distance-tubes between the risers it is important to

ensure that the risers are not pulled together by the system (use webbing loops designed for climbing to increase the length of your release system). It is also very important to fit a bungee to the system that will keep it from hitting you in the face in the event of a towing line failure



**BEWARE!** If you are using a front-mounted reserve system it is very important to verify the unhindered deployment before every flight. In case of doubt please only tow using a textile release system.

## Flight safety

The development of high performance paragliders from square parachutes has meant vast improvements in speed, sink rate and handling. But, at the same time, it has also led to a requirement on behalf of the pilot for accurate, sensitive control and an acute anticipation of possible flying conditions. Any glider, whether beginner or competition class, may collapse in turbulent conditions and you must be able to react accordingly.

Today you have a wide choice between different gliders in the UP range. The main difference between the gliders is in the stability that each class offers. Beginner wings react to turbulence less dramatically and are more forgiving when compared to top performance gliders, which have more sensitive, but less forgiving handling. Making the correct decision when choosing a new glider is most important; you should critically examine your flying and your level of knowledge.

A safe and efficient way to get used to your new paraglider is by practising your ground handling skills. We suggest

finding a suitable area, like a playing field, and with light to medium wind it is quite easy to practice inflating the glider and feel the reaction to brake input, b-line stall, collapses etc.

Before takeoff and whilst flying it is very important to anticipate any likely turbulence and fly accordingly. Look well ahead, and as well as looking for areas of likely lift, try and predict, and avoid, areas of sink and rough air. If you do find yourself in turbulence then look for the cause, and adjust your flight plan to avoid other similar places.

## Thermals and Turbulence

In turbulent air, the UP Lhotse should be flown with a little brake to increase the angle of attack and provide greater stability. While flying in strong or broken thermals, it is important that you concentrate on keeping the wing centrally above your head. Do this by allowing the glider to fly faster while entering a thermal, and by dampening the surge of the canopy while exiting the thermal by braking gently.

Flying fast is useful for getting through sink or when flying into a headwind. The UP Lhotse possesses a high inherent stability due to its construction and design, however an active flying style in turbulence will help increase safety by preventing unnecessary collapses and deformation of the canopy.

## Getting down fast

All rapid descent manoeuvres should be practised initially in smooth conditions with plenty of altitude before you need to use them 'for real'. It is important to distinguish between the

three techniques, and to know the merits of each.



**WARNING!** All other manoeuvres, such as full stalls and spins, should be avoided as fast descent techniques. They are not very efficient, and incorrect recovery can have

dangerous consequences (as with any paraglider)!

## Steep Spiral Dive

A maximum sink rate of over 15 meters per second can be achieved in a steep spiral dive, but it is advisable to build up gradually to these sink rates when you first practise spiralling.

Getting the UP Lhotse into a spiral dive is very simple and has already been described in the chapter regarding turning. When entering the spiral it is essential to induce the turn gradually; if you apply the brake too quickly you may enter a spin. If this happens, release the brake immediately and let the glider recover before trying again. Keep a steady tension on the inside brake and observe the increased angle of bank and sink rate. A little brake on the outer wing will help stabilize the glider at a high sink rate.

To recover from a spiral, simply release the inside brake. Do this gradually to prevent an uncontrolled steep climb caused by the excess energy built up during the dive. Be prepared for the glider to climb a little and to damp out the subsequent dive. Be warned that steep spiral dives are equal to high G loading on both you and your glider!



**WARNING!** Spiral dives with high sink rates expose the pilot and material to very high centrifugal forces –

incidents caused by pilots falling unconscious during spiral dives have been recorded. Approach this manoeuvre with caution. NEVER fly a spiral dive with Big Ears engaged – this could lead to a catastrophic material failure!

## B-Line Stalls

To induce a B-line stall, start from normal, un-accelerated flight. Reach up and take hold of both B risers, still with your hands in the brake loops, and pull down simultaneously by approximately 20-25 cm. The first few centimetres of travel will be quite hard, but as the glider settles into the stall so the effort becomes less.

The glider will drop back a little as it stalls, and then centralize over your head. With 25 cm or so of pull a sink rate of up to 9 meters per second can be achieved. With less pull you will get a decrease in sink rate. The B-risers should not be pulled beyond this point, as it may result in the canopy entering an unstable phase or going into a frontal rosette. Should you inadvertently have pulled too far down on the B-risers, simply release them a little again until the wing is again stable above you, showing the characteristic deep crease along the B-level and being fully stretched out spanwise.



### BEWARE!

Always check visually the canopy for the frontal rosette during the B-stall and release the B-riser if necessary.

To recover from a B-line stall, the risers should be released abruptly and simultaneously. Doing so will allow the wing to re-inflate completely and



resume normal flight. It is not unusual for the canopy to dive in front of the pilot as the wing regains speed, angles of up to 30-45° are perfectly normal. In this phase the pilot should NOT engage the brakes!



**WARNING!** Releasing the B-stall too slowly, or asymmetrically, can lead to dangerous situations. Always practise manoeuvres under professional guidance and over water!

## Big Ears

To pull the ears in, reach up and get hold of the outermost A-line on both front risers and pull them down, simultaneously, by about 20 to 30 cm until the tips collapse. Keep these two lines in your hands, to prevent the wing re-inflating.

Once the wing is flying in the Big Ears configuration we recommend engaging the speed system to about 50% of the maximum travel (more if higher sink rates are desired). This reduces the angle of incidence and improves the safety of the manoeuvres.

We suggest keeping the brake toggles in your hands while inducing Big Ears. The glider will remain fully steer-able through weight shifting during the manoeuvre. The sink rates will be around 3 to 5 meters per second (depending on the number of centre cells still open and on the amount of speed bar employed) straight ahead. To end the Big Ears configuration, simply release the A risers and disengage the speed system, and the wing will return to level flight. Small collapses may be cleared with directional changes and/or little pumps through the brake lines. Note that we advise against performing extreme manoeuvres while flying in the Big Ears configuration.

Inducing large Big Ears on the UP Lhotse when flying near its lower weight limit requires great caution on the amount of brake input used, as it may deep stall in extreme cases. Should this happen use the recovery technique described in the 'Deep Stall' section.

## Flying outside the normal flight envelope

### Behaviour in extreme situations

The UP Lhotse is designed to be very aerodynamically stable. However as with all paragliders extreme turbulence or piloting error may induce unwanted behaviour from the canopy. To ensure that you are able to handle these situations correctly we strongly recommend that you attend a safety-training (SIV) clinic, where you may learn to master your wing outside the normal flying envelope under professional guidance.

Safety training manoeuvres should only be practised in calm air with sufficient altitude, and under the instruction of qualified instructors. We would like to use this occasion to once again remind you to never fly without a reserve parachute!

The manoeuvres and possible flight configurations described in the following may occur following a conscious effort on the part of the pilot, through turbulence or through pilot input error. Any pilot flying in turbulent air or making piloting mistakes may end up experiencing these flight configurations and therefore find

themselves in danger, particularly if they are not adequately trained to master them.



**WARNING!** Mistakes during the execution of the following manoeuvres may seriously compromise the safety of pilot.

## Collapsing the paraglider

### Asymmetric collapse

The UP Lhotse belongs to the new generation of paragliders that, as well as having very good performance, also exhibit a high degree of stability. Wing tip collapses can almost always be prevented through active flying.

Once an asymmetric collapse has occurred, the pilot aims to maintain flying direction through weight shift and careful application of brake input on the open side.

If the open side is braked too much it may stall, and the wing will enter a spin – this is the classical recipe for cascading events (see the spin chapter).

In rare instances a wingtip may catch in the lines during asymmetric collapses (see cravats here below).

### Cravatte

Our test pilots have found absolutely NO tendency towards cravating in all the test flights the Lhotse has been subjected to. But under extraordinary circumstances any paraglider may cravatte, and if this happens the pilot should know how to deal with the situation.

The first step is to STOP any rotation, or, if this is not possible, to slow down the rotation as much as possible – a cravatted wing that is left to its own devices may very quickly enter into a spiral dive of such

vehemence that the pilot cannot stop the rotation any more. Once the rotation is under control the pilot attempts to free the cravatte by pulling on the (purple) stabilo line, perhaps in combination with pumping action through the brake lines.



If neither of these approaches work then the experts may decide to try either a full stall or a brief spin on the cravatted side – please note that these measures should ONLY be practised during an SIV training over water.



**WARNING!** Should the pilot be unable to control the rotation it is normally best to deploy the reserve parachute immediately. Uncontrolled and cravatted spiral dives are among the most dangerous canopy configurations in paragliding

### Full frontal collapse

A negative angle of attack occurring through turbulence or from simultaneously pulling down both A-risers results in a full frontal collapse of the leading edge of the canopy. The UP Lhotse will normally reinflate quickly on its own, but can be assisted through the application of a light double-sided symmetrical brake input.

## The stalls

When a paraglider flies through the air a laminar and a turbulent airflow forms around the surface of the wing. When the laminar airflow along the top surface is interrupted, dangerous flight configurations follow – we say that the wing stalls. This is most often the

consequence of attempting to fly with too high angle of attack.

In more detail we differ between three different forms of stall.

**BEWARE!** Spin and full stall are both dangerous and somewhat unpredictable manoeuvres. Do not stall or spin your paraglider on purpose. However it is very important to learn how to recognize the symptoms of a glider about to stall or spin so that you can take correct action to avoid it happening.

## Deep Stall

The UP Lhotse has no inherent tendency towards deep stall. It will recover from a deep stall brought about by over-braking, by pulling on the rear risers, or by releasing the B-risers too slowly after a B-stall, on its own without any pilot input as soon as the brakes or the risers are released.

Should you however find yourself in a deep stall (as described above, this could happen through flying too light on the wing and pulling big ears) the situation can be rectified by simultaneously pushing both A-risers forward until the glider resumes normal flight. Avoid applying brake to one side if you think that you are in a deep stall as this could lead to a spin.

Always remember that practising manoeuvres where you fly close to minimum airspeed must only be carried out under professional supervision and with plenty of altitude.

## Fullstall

Wilfully induced full stalls remains the realm of the true experts of our sport.

The full stall is when there is no more laminar airflow along the surface of the canopy, and the wing has gone from being

a wing to being just a bunch of material at the end of some lines.

Once the airspeed has been reduced to below the minimum speed for the canopy the wing will stall. To the pilot it feels like dropping backwards, not unlike the sensation felt when a jester removes your chair from under you when you sit down. In this phase it is important to avoid releasing the brakes again, as this may lead to uncontrollable shooting forward of the canopy. In extreme cases pilots have fallen into the canopy through poorly timed full stall releases.

In the next phase the canopy stabilises somewhat above the pilot again. The wing tips will often tend to try to reinflate quite violently, and it requires considerable force to maintain the wing in the stalled configuration.

It is important to stabilise the wing above the pilots' head before releasing the brake lines. The pilot accomplishes this by slowly releasing the brakes until the wing is all but reinflated across the entire span. In this phase the wing will be moving somewhat along the cross axis. The pilot attempts to release the last bit of brake input as the wing is surged forward – this will cause the wing to resume flight with the least possible diving tendency. Pilots should note that timing the release wrongly may cause the wing to dive quite aggressively and be prepared to catch the dive.

Test pilots have also tested the asymmetric release of full stalls on the Lhotse. This manoeuvre is **ONLY** for reference and should not be emulated by owners.



**CAREFUL!** The approach of the minimum speed is recognised through the

notable lack of forward speed and thereby wind noise and the extreme increase in brake line tension. Up until the wing starts to fall back the pilot may resume normal flight by simply releasing the brakes.

## Spin

The negative spin occurs when one side of the wing is stalled while the other is still flying. This can happen when, if flying very slowly, one brake is pulled quickly to below the seat. When the glider starts to spin, it will turn quickly around the vertical axis, with the stalled side flying backwards. To recover from a spin, simply release the brake on the stalled side. The glider will immediately speed up and, most likely, suffer an asymmetric collapse. Recover as described above.

If you suspect that a spin is imminent then immediately release the inside brake. The glider will accelerate smoothly and resume normal flight with little altitude loss.

## Wingovers

Wingovers are induced by flying alternating turns; each time letting the pendulum effect increase the bank angle.



**BEWARE!** The UP Lhotse is a agile glider, and it is quite easy to get to an excessively high angle of bank in just a few turns. Practice wingovers gently at first, as there is a chance of quite large collapses at high bank angles.

Also notice that a wingover flown with more than 135 degrees bank angle is classified as illegal aerobatics in some countries!

## Emergency Steering

If for some reason the UP Lhotse cannot be controlled with the brakes, for example if the brake handle has come off the main brake line, it can be steered and landed with the rear risers. Be aware that, when rear riser steering, the glider is a great deal more responsive to pilot input, and the stall happens very suddenly.

## Further references

### Rain-induced deep stall

There are two reasons why flying with a wet wing increases the risk of deep stalling:

First reason: A paraglider flying in heavy rain will soon grow significantly heavier and thereby undergo changes in the centre of gravity and the angle of incidence. This may lead to deep stalls. Note that older wings will absorb more water than newer ones due to the coating on older wings being more permeable – this means that the critical mass may be reached sooner on older wings.

Second reason has to do with the actual rain drops on the top surface – if enough large rain drops form that the entire top surface is covered, but they don't join together to either flow off or become a homogeneous mass, the surface may become so rugged that the airflow separates and the wing stalls.

This phenomenon has been observed on hang-gliders and gliders for years but only recently have we discovered that paragliders may also be affected. It is more likely to happen with new wings where the cloth is still highly hydrophobic and the drops thus do not penetrate but remain on the surface.

We know from computer simulations and practical tests that this is physically possible but we also suspect that it occurs very seldom in real life flying.

In both cases the brakeline travel becomes very short and even small input may suddenly induce an airflow separation; in some cases even a gust or a sudden thermal may change the angle of incidence enough to cause the deep stall.

If you find yourself flying in unavoidable rain we strongly recommend that you avoid any sudden movements or radical brakeline input, that you do not pull Big Ears or B-stall, and that you steer clear of turbulence and avoid a deep flare on landing.



**WARNING!** Avoid flying in very humid air or in rain. A wet canopy may have very unpredictable flying characteristics, one of which is a radically increased risk of deep stall!

## Adhesive logos

Always make sure that your intended logo will not in any way influence the glider behaviour. If in doubt we suggest avoiding the attachment of advertising logos on the wing. UP cannot be held responsible for any mishaps caused by intentional after-sales changes done to the wing.



**NOTE!** The use of heavy and/or unsuitable sticky material for logo work on the canopy may compromise the certification and lead to the aircraft becoming unsafe to fly.

## Overloading

The UP Lhotse is a very strong paraglider, and flying all the usual SIV and acro manoeuvres will not normally pose a structural problem. However, frequent acro training does accelerate the ageing process dramatically, and UP recommends having wings that are often used for acro or SIV-type manoeuvres subjected to checkups at shorter intervals than normally stipulated.

## Salt water

If you do most of your flying near the sea, where the air is humid and salty, the wing may age faster. In this case we suggest you have it checked more often than prescribed in this manual.

## Maintenance and cleaning

### Taking care of your paraglider

The wear and tear that your paraglider suffers depends on a number of factors; how frequently it is flown, whereabouts in the world you fly it, how much UV it gets and how well you look after it. Bear in mind the following maintenance points.

### Packing the wing

The FSS battens are insusceptible to bending damage. This means the Lhotse may be folded as per pilot preference in the spanwise direction. The pilot may opt to fold the wingtips towards the centre, to fold along each

cell wall, or to use the now ubiquitous accordion method (see illustrations). Regardless of pilot preference we recommend alternating the packing

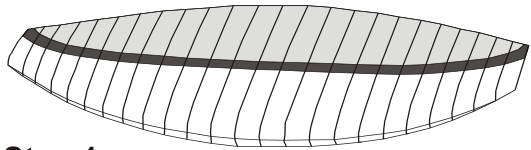

**Step 1**

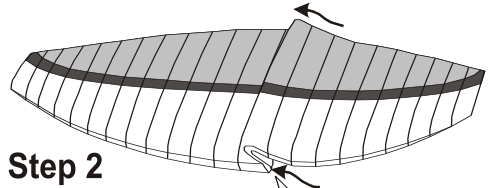

**Step 2**

**Step 3**

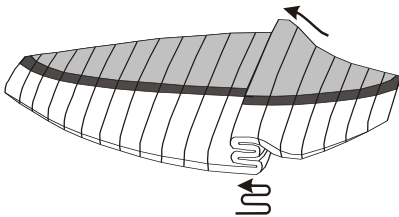

**Step 4**

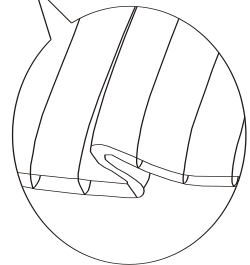
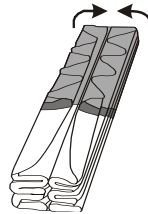

**Detail**

**Abbildung 8: Packing the UP Lhotse**

methods a little every time, especially around the middle of the canopy, as this area is particularly exposed to mechanical abrasion in the folding process. We also recommend to always place the canopy on the compression bag before folding along the chord – this will protect against soil abrasion.

In order to prolong the life of the FSS battens we recommend the following procedure when folding the canopy in the chord-wise direction:





Start by gathering the two sides into a narrow "sausage"



Then proceed to fold from the trailing edge..,



... towards the leading edge...



Do NOT fold the leading edge inside the bundle



Instead, keep the entire leading edge on the outside of the bundle, and secure with the UP compression strap.

## Paraglider fabric

We use a top grade polyamide fabric to build our paragliders. The fabric has a special protective coating against UV radiation and air permeability. The fabric may suffer if it is exposed to large amounts of UV radiation (i.e. bright sunlight). Do not leave your glider lying in the sun for any longer than absolutely necessary, only unpack and rig right before launching and do yourself the favour of repacking right after landing. Modern paraglider textiles have improved much in terms of UV durability but UV exposure remains the deciding factor of a paragliders' life expectancy. First the colours start to fade, then the coating and the structural integrity of the synthetic fibres begins to deteriorate.

On UP gliders the coated side of the cloth is facing inwards. This means

that the coating is subjected to less mechanical abrasion while the porosity-limiting capabilities remain the same

When choosing an area to lay out the glider before launching, try to find somewhere that is relatively free of stones and sharp rocks. Pay particular attention to the top surface, where it lies on the ground.

Never step on your glider – stepping on it will weaken the cloth, especially if the surface beneath it is hard or contains sharp objects. We recommend keeping an eye on spectators on launch. Many, especially children, do not fully appreciate the fragility of the lines and cloth. It is usually easy to explain this to spectators and parents.

When folding your wing please make sure that there are no insects caught inside. Many insect species contain acids that could damage the cloth. Grasshoppers may use their sharp mandibles to attempt to gnaw their way out of a folded canopy, making it full of holes in the process. Further they exude a dark and strong colourant that will stain the cloth if grasshoppers are packed inside. Shoo them off before packing. Note that, contrary to popular belief these particular insects are not attracted to any particular colours.

If the glider gets wet, then dry it as soon as possible, but not in direct sunlight! If you pack your wing away wet it may grow mildew and, if also subjected to heat, the fabric fibres may begin to decompose.

A new wing straight off the shelves is often compressed hard. The compression serves to reduce shipping costs but should not be repeated once the wing has been unpacked and flown for the first time. Also note that, in spite of it being a comfortable seat, the glider bag should not be used as such.

Should you accidentally put your UP Lhotse into seawater, rinse it out thoroughly with fresh water and dry it slowly in the shade (see Chapter Cleaning).

## Paraglider lines

The lines used on the UP Lhotse are high grade sheeted and unsheeted Dyneema® and Aramid lines. Keep the following points in mind:

- The lines should be checked regularly for damage,
- Please take care to avoid abrasion and damage to the lines' protective sheeting,
- The lines should not be knotted or bent unnecessarily,
- The main brake line at the handle should not have too many knots. Each knot weakens the line,
- After any line over-stressing (tree landings, water landings and other extreme situations) all lines must be checked for condition and length and should be replaced where necessary,
- If any change in flying characteristics is noticed then the lines should be checked and possibly exchanged. Immediately send your wing to UP International or to a UP certified checking facility if you feel that something is wrong!

## Storage and transport

A paraglider should always be dry when packed, but this is particularly important after the last flight of the season. But even a completely dry wing should still be stored open in a dry, clean and dark place. If you do not have room for such winter storage we



recommend you open all compression straps on the bag as much as possible and leave the bag lid off so that air can circulate around the packed canopy. Make sure no mice or cats make their sleeping quarters in you wing, and keep it well distant from solvents and acids. Petrol and other petrochemicals is especially abrasive for nylon and will dissolve the cloth if allowed near.

The long-term storage temperature should remain approximately constant between 10 and 25 degrees Celsius, and the relative humidity between 50 and 75%.

Do not expose your UP Lhotse to extreme heat (storing it in the boot of a car parked in the sun). The heat may cause moisture to be pressed through the fabric, thereby damaging the coating. High temperatures in combination with moisture are a particularly volatile mix that will accelerate the hydrolysis process where the fibres and the coating are decomposed. The chemical composition of the canopy material may begin to change from temperatures as low as 60 degrees Celsius !

## Cleaning

If you feel it necessary to clean your UP Lhotse at any time then use lots of lukewarm water and a soft sponge. More stubborn stains can be cleaned with a weak soap solution, and rinsed thoroughly. Then leave it to dry in a shady but well-ventilated area.



**BEWARE!** Never use chemical cleaning agents, brushes or hard sponges on the material, as these destroy the coating and affect the strength of the cloth.

The canopy will become porous and will loose structural strength. Never

attempt to clean your paraglider in a washing machine. Even without using detergents the simple mechanical abrasion will quickly finish the canopy and render it useless. Also avoid dipping it in a swimming pool; the chlorine will damage the cloth. If you **MUST** rinse the parachute, e.g. following a sea water landing, do so with a gentle spray of fresh water. Frequent spraying will accelerate the ageing process.

## Changing FSS Battens

The UP Lhotse uses flexible Nylon® battens to maintain the shape of the leading edge. They are insusceptible to bending damage and very robust, but may in extreme cases become bent or broken – fear not, for they are easily replaced on-site! A small pocket at the top end of the batten allows it to be released from the confines of the little tunnel it resides in.



Push the batten back somewhat and release the end from the pocket, then remove it entirely. Transfer the total length precisely to the replacement material (supplied) and cut a new length. File the ends of the new batten and cover them with tape. Push the new batten into place and secure.



(FSS similar to Lhotse)

## Checks and repairs



Repairs and periodic checks should **ONLY** be carried out by UP, or by UP approved checking centres. Failure to comply with this will forfeit the certification. Consult: [www.up-paragliders.com](http://www.up-paragliders.com) under Service to find a check centre near you.

At UP we invest our entire knowhow in paragliding into making the sport safer for you. We offer a variety of services all centred around safety to our customers.

## Maintenance

All care and maintenance must be carried out in accordance with UP recommendations. To ensure that this happens we strongly advise you to only let UP recognised service centres touch your wing – this is also a prerequisite for the UP warranty to be valid. So there's a lot speaking for letting UP, or a UP affiliate, look after your Lhotse!

## Airworthiness Check

In Germany and Austria all paragliders must be checked according to the following time schedule:

- 2 years after the first flight
- Every 2 years after that, or sooner if prescribed by the UP checking facility during the last check
- After 150 hours of flying
- After 100 flights

These limits have been set by the German Free Flight Federation (DHV) and make no less sense for wings flown outside of Germany/Austria. Contact your local dealer for information about the nearest UP approved checking facility.

We will happily service the glider more often, if you feel that it is necessary.



**CAREFUL!** If you notice new or unusual behaviour from your wing please hand it in for immediate inspection at a UP Service centre.

## UP Craftsmanship

In order to ensure that your UP Lhotse maintains its very high inherent performance and safety we highly recommend that you employ UP, or a UP affiliate, with any repairs or maintenance. Our service staff is trained and skilled, and knows the UP wings better than anyone.

## UP Warranty

Conditions and extent of the UP International Warranty can be found in the following pages. For further

information please ask UP International directly, or your local representative. The UP importer in your country is always delighted to clear any questions with you.

## National warranty conditions

In some countries the local laws stipulate different warranty rules than those outlined here. Please note that these local rules only apply in the country where you have purchased your wing. Information about local rules and conditions are available from your local dealer.

## International UP warranty

### Warranty conditions:

The international UP warranty covers material- and workmanship faults and is valid for 24 months from the delivery date.

The UP warranty covers the cost of materials and workmanship on gliders accepted by UP to fall under the warranty. The UP warranty does not cover damage caused by accidents, or by changes made to the glider. Likewise, parts that are damaged due to normal wear and tear are exempt from warranty coverage. Fabric colour changes that do not influence the behaviour or safety of the wing are not covered by the warranty, and neither are faults caused by the exposure to solvents or salt water, or plain incorrect handling of the wing.

### For any warranty claim to be accepted the following conditions must be adhered to:

- The paraglider was used under normal circumstances and was maintained according to the instructions given by UP International. Note that these include instruction for the correct packing, storing and cleaning.

- The paraglider was only used in accordance with its DHV certification.
- A complete logbook showing all flights, with duration and location, must be presented upon request.
- Only original UP spares have been used, and only UP, or a UP affiliate service centre, has performed repairs or service jobs on the paraglider.
- A complete, correct registration card has been filled in and sent to UP within 14 days of the purchase. Note that you may also register your paraglider with UP via the UP homepage:  
[www.up-paragliders.com](http://www.up-paragliders.com)  
>service >UP Product registration

UP reserves the right to refuse any claims not honouring one or several of these conditions. However, in some cases an "ex gratia" settlement may be offered.

## Checking the UP Lhotse

According to German and Austrian aeronautical legislation (§ 14 Abs. 5 LuftGerP) the owner of a glider can check the airworthiness by his own, or authorise a third person (for example manufacturer/importer) to do this.

To perform your own airworthiness check, UP International must give you a briefing. This briefing could be done after an agreement with UP International and is only valid for the UP Lhotse. The owner gets the so-called "Nachprüfanweisung" after completing a successful checking at UP International.

Should the owner decide to check the wing by himself, or employ a 3<sup>rd</sup> party

to do so, they must make sure that UP's guidelines are adhered to. Failing to do so will void the certification.

DHV and UP International highly recommend that you let the manufacturer/importer or a DHV accepted service company do the check of airworthiness.

## **Packing and checking of the rescue system**

Only by regularly having your rescue parachute repacked can you guarantee its flawless operation! As with the glider, the rescue parachute should be examined every 2 years by either the manufacturer or an authorised Service Centre. We offer a certified service for re-packing, checking and installing the parachute into your harness. We will also carry out any repairs necessary, all fully guaranteed.

## **Sending the UP glider and other UP products**

The best way to send your paraglider, rescue parachute, harness etc. to our service team is in a stable box via post or UPS. Enclose a note of what requires doing (2 Year Check, repair, repack etc.) and also your daytime contact details. We will return your equipment either by post or UPS. Please indicate preferred method of payment (either bank cheque or Cod).

Should you require any further information about the services we offer, please contact us at the address and phone number below. We are also able to give you information about your nearest Authorised Service Centre, as well as other manufacturers who are authorised to check and repair UP gliders and equipment.

UP International GmbH  
-Abteilung Service-  
Kreuzeckbahnstraße 7  
D-82467 Garmisch-Partenkirchen  
GERMANY

Email: [service@up-europe.com](mailto:service@up-europe.com)  
Telefon: +49 (0) 88 21-7 30 99-0  
Fax: +49 (0) 88 51-92 92 60-16

## **Disposal**

Even the best products have a limited service life, and once the end is at hand they must be disposed of properly.

Please make sure you follow your finished paraglider all the way to a correct disposal, or send it back to UP International for correct disposal.

## **UP Homepage**

The UP Homepage gives you information about the latest news and products from UP. You will find any technical information and accessories for your UP Lhotse, as well as many useful things that are necessary for flying.

Beside paragliders, harnesses and flying equipment you will also find the new "Skywear" collection with the latest flying garments and the "News" section, which will keep you updated with all activities around UP.

[www.up-paragliders.com](http://www.up-paragliders.com)

---

## Some final words

\* from Helmut Reichmann from the book  
"Streckensegelflug"

With paragliding a fundamental new air sport has emerged; one that makes independent flight possible for almost everybody. The technical simplicity, the mobility of the wing and the ease of learning the basic flight techniques have all combined to make paragliding appear simple and straightforward.

As long as you fly with the necessary respect for the demands and dangers, then these ideals of paragliding will be fulfilled. You should decide for yourself whether conditions are suitable before you proceed with the flight. You should always be aware that any kind of air sport is potentially dangerous if you overstep the natural and physical laws, whether from ignorance or unreasonableness.

"Probably there are only a few sports where success requires, besides physical fitness, understanding the processes in nature to such a high degree - a fact which distinguishes paragliding as sport especially."\* The charm of flying lies in "understanding the processes in nature", because you have to try again and again to fathom the logic and fly with regard to the decisions you make.

If you want to realise the dream of flying, the dream of free movement in the air, fly not to impress others - fly for the sheer joy of it.

We at UP wish you delightful, beautiful and accident free flying with your UP Lhotse!

SEE YOU UP IN THE SKY –  
UPInternational

# Attachments

## Line plan

UP Lhoise line map

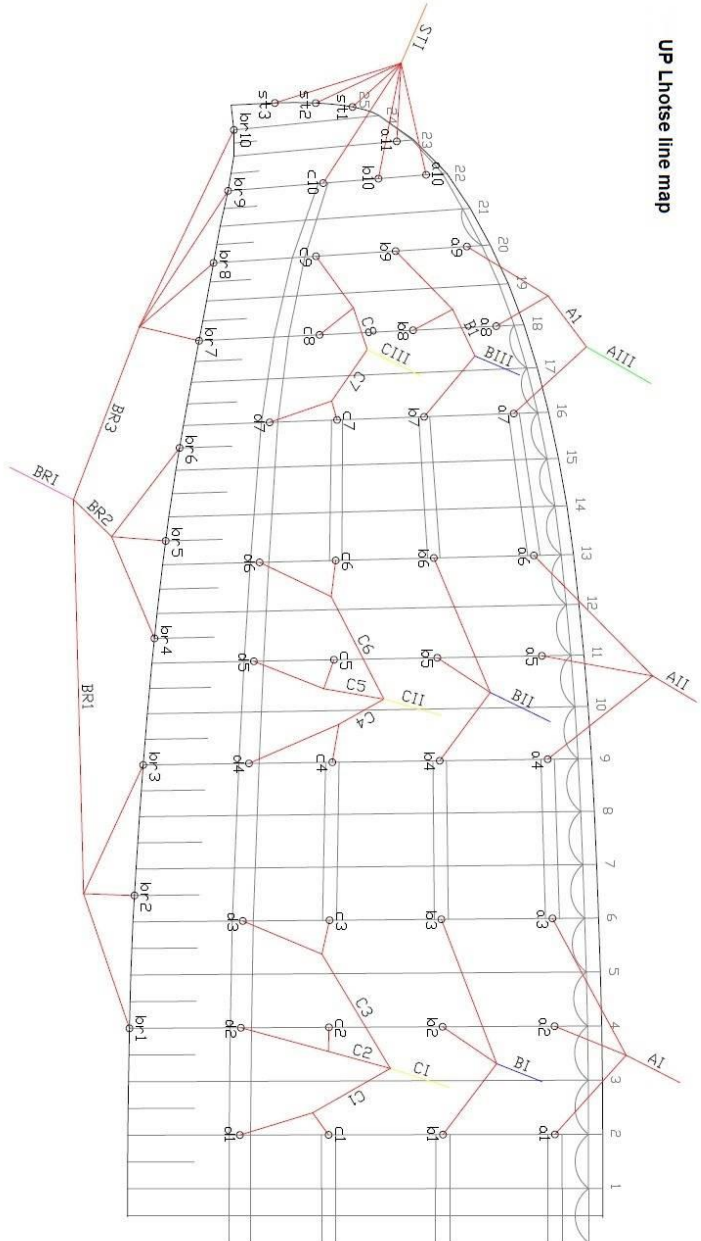

# Line Data

	UP Lhotse L	UP Lhotse M	UP Lhotse S
Leine / Line	Länge / Length [mm]	Länge / Length [mm]	Länge / Length [mm]
a1	7007	6749	6437
a2	6931	6677	6366
a3	6964	6707	6393
a4	6933	6676	6358
a5	6861	6607	6294
a6	6886	6629	6314
a7	6802	6548	6235
a8	6690	6444	6136
a9	6621	6376	6070
a10	6377	6140	5855
a11	6244	6013	5734
b1	6949	6696	6386
b2	6870	6621	6312
b3	6903	6652	6340
b4	6871	6620	6305
b5	6799	6551	6241
b6	6826	6576	6261
b7	6736	6489	6181
b8	6636	6392	6086
b9	6576	6331	6026
b10	6330	6096	5811
c1	7002	6742	6423
c2	6912	6657	6338
c3	6954	6695	6375
c4	6916	6657	6341
c5	6832	6577	6264
c6	6869	6610	6296
c7	6776	6525	6213
c8	6674	6426	6118
c9	6616	6369	6064
c10	6366	6130	5844
d1	7162	6887	6560
d2	7072	6801	6477
d3	7106	6834	6509
d4	7064	6793	6467
d5	6969	6703	6382
d6	6990	6722	6403
d7	6874	6618	6299
br1	7723	7406	7103
br2	7390	7086	6793
br3	7301	6999	6715
br4	7154	6858	6575
br5	7017	6726	6448
br6	7058	6765	6486
br7	6947	6658	6378
br8	6853	6564	6287
br9	6826	6535	6259
br10	6839	6546	6273
st1	6157	5928	5655
st2	6170	5940	5666
st3	6242	6008	5737

## Service booklet

### Glider- and pilot data

<b>Model:</b>	<b>Lhotse</b>
Size:	<input type="checkbox"/> S <input type="checkbox"/> M <input type="checkbox"/> L
Serial number:	_____
Colour:	_____
Date of purchase:	_____
First flight date:	_____
Dealer stamp and signature	

<b>Pilot (1. owner)</b>
Name: _____
Family name: _____
Street: _____
Town: _____
Postal code: _____
Country: _____
Telephone: _____
Fax: _____
Email: _____



**Pilot (2. owner)**

Name: \_\_\_\_\_

Family name: \_\_\_\_\_

Street: \_\_\_\_\_

Town: \_\_\_\_\_

Postal code: \_\_\_\_\_

Country: \_\_\_\_\_

Telephone: \_\_\_\_\_

Fax: \_\_\_\_\_

Email: \_\_\_\_\_

**Pilot (3. owner)**

Name: \_\_\_\_\_

Family name: \_\_\_\_\_

Street: \_\_\_\_\_

Town: \_\_\_\_\_

Postal code: \_\_\_\_\_

Country: \_\_\_\_\_

Telephone: \_\_\_\_\_

Fax: \_\_\_\_\_

Email: \_\_\_\_\_

Please verify that your UP Service Centre has correctly filled in the form!

### 1st Service

Performed date: \_\_\_\_\_

Assignment Nr.  
Stamp

Service jobs undertaken:

### 2nd Service

Performed date: \_\_\_\_\_

Assignment Nr.  
Stamp

Service jobs undertaken:

### 3rd Service

Performed date: \_\_\_\_\_

Assignment Nr.  
Stamp

Service jobs undertaken:

Please verify that your UP Service Centre has correctly filled in the form!

### 4th Service

Performed date: \_\_\_\_\_

Assignment Nr.  
Stamp

Service jobs undertaken:

### 5th Service

Performed date: \_\_\_\_\_

Assignment Nr.  
Stamp

Service jobs undertaken:

### 6th Service

Performed date: \_\_\_\_\_

Assignment Nr.  
Stamp

Service jobs undertaken:



# Product registration card

**Model:** Lhotse

**Size:**  S  M  L

Serial number: \_\_\_\_\_

Date of purchase: \_\_\_\_\_

First flight: \_\_\_\_\_

Preflown by: \_\_\_\_\_

## Owner

Name: \_\_\_\_\_

Family name: \_\_\_\_\_

Address: \_\_\_\_\_

\_\_\_\_\_

\_\_\_\_\_

Telephone: \_\_\_\_\_

Fax: \_\_\_\_\_

Email: \_\_\_\_\_

Dealer stamp and signature

**Cut out this card and mail it to UP within 14 days of purchase, or register your new UP Lhotse via [www.up-paragliders.com](http://www.up-paragliders.com)>Service>UP>Product Registration**



UP International GmbH  
Kreuzeckbahnstrasse 7  
82467 Garmisch-Partenkirchen  
**GERMANY**

